



EWM-SP-DAD

CARD FOR AXIS CONTROL WITH PRESSURE LIMITATION IN CLOSED LOOP. PROFIBUS INTERFACE SERIES 21

**RAIL MOUNTING TYPE:
DIN EN 50022**

OPERATING PRINCIPLE

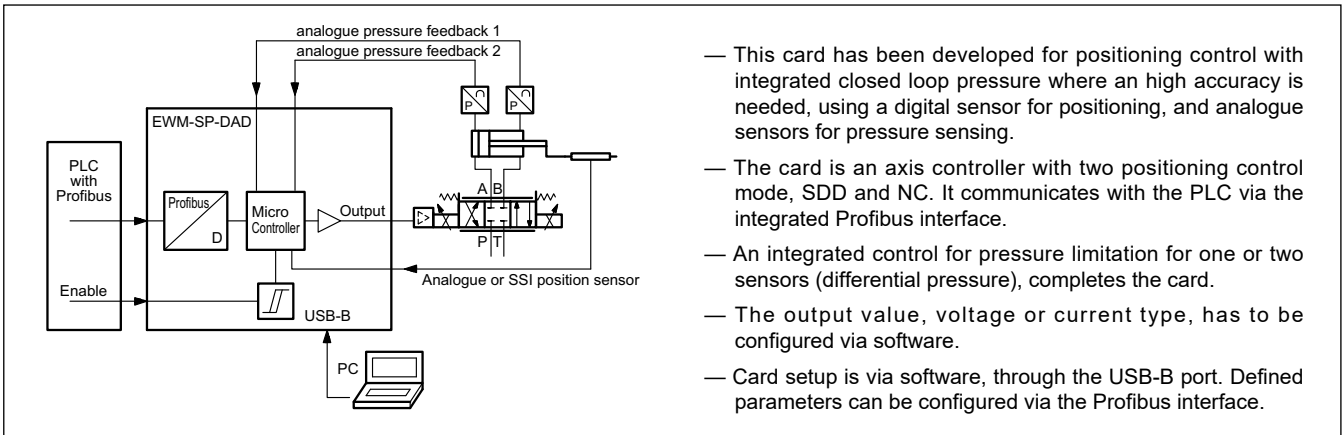

- This card has been developed for positioning control with integrated closed loop pressure where an high accuracy is needed, using a digital sensor for positioning, and analogue sensors for pressure sensing.
- The card is an axis controller with two positioning control mode, SDD and NC. It communicates with the PLC via the integrated Profibus interface.
- An integrated control for pressure limitation for one or two sensors (differential pressure), completes the card.
- The output value, voltage or current type, has to be configured via software.
- Card setup is via software, through the USB-B port. Defined parameters can be configured via the Profibus interface.

TECHNICAL CHARACTERISTICS

Power supply	V DC	24 ÷ 30 ripple included
Fuse, external	A	1A medium time lag
Current consumption	mA	<350 (technical data of the sensors have to be considered)
Command position		via Profibus DP
Profibus DP data rate	kbit/s	9.6, 19.2, 93.75, 187.5, 500, 1500, 3000, 6000, 12000 - ID number 1810h
Max position accuracy	µm	1
Position feedback values	SSI V mA	digital sensor with any interface SSI - 150 kbit/s 4 ÷ 20 (RI = 240 ohm) 0 ÷ 10 (RI = 25 kohm)
Pressure feedback values	V mA	4 ÷ 20 (RI = 240 ohm) 0 ÷ 10 (RI = 25 kohm)
Output value	V mA	differential, ±10 (max load 10 mA) 4 ÷ 20 (max load 390 ohm)
Interface		USB - B 2.0 / Profibus
Electromagnetic compatibility (EMC)		Immunity EN 61000-6-2: 8/2005 Emissions EN 61000-6-4: 6/2007; A1:2011
Housing material		thermoplastic polyamide PA6.6 - combustibility class V0 (UL94)
Housing dimensions	mm	120(d) x 99(h) x 46(w)
Connections		USB-B (2.0) - 7x4 poles screw terminals - PE direct via DIN rail
Operating temperature range	°C	-20 / +60
Protection degree		IP20

1 - IDENTIFICATION CODE

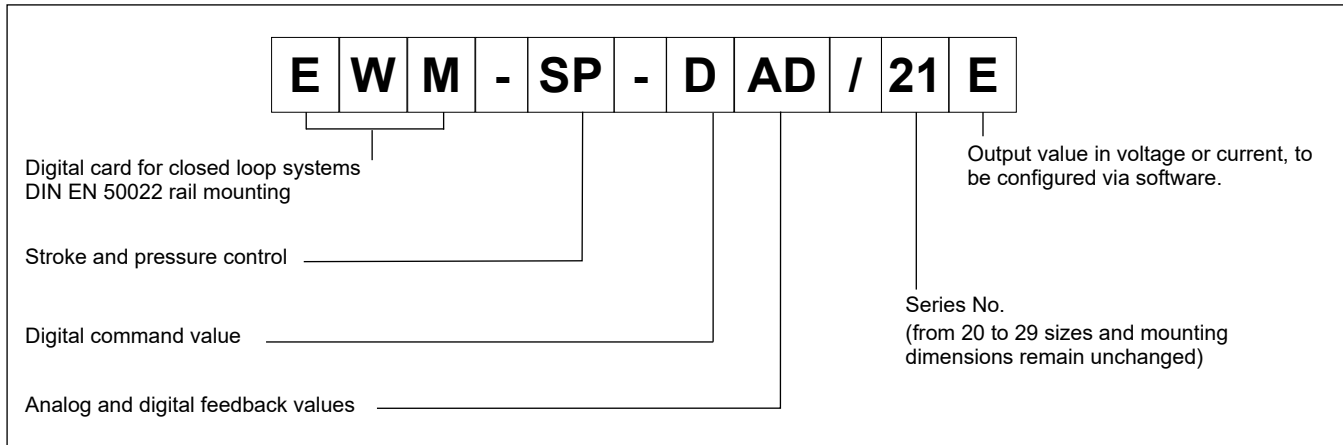

2 - FEATURES OVERVIEW

Controller Functions

- Stroke or stroke + pressure limitation control in closed loop system
- Fine positioning - 1 µm resolution
- 2 method for positioning control:
 - SDD – Stroke Depending Deceleration - time-optimal positioning structure with very high stability
 - NC – Numerically Controlled - To follow the position profile
- Second position and second speed commands available for fast approach / test speed
- Data for lengths and pressures in mm and bar / % respectively
- Gain adjustment made via software
- PT1 filter to stabilize the control behaviour
- Emergency function (EOU)
- Safe and error-free data transmission
- For digital position sensors
- Internal limitation of velocity for position sensors
- As an alternative, the card can be set via software for operate with analogue position sensors.
- Two analogue feedback for differential pressure measurement
- Two sets of PID and ramp parameters for pressure control
- Simple and intuitive scaling for analogue sensors

Adaptation of the valve characteristic curve

- CTRL function to adapt the braking characteristics to positive and zero overlapped proportional valves
- Advanced deadband compensation: non-linearity compensation by a double-gain characteristics
- Drift compensation

Monitoring functions

- In-position error
- Cable break, in-pressure error and fault of feedback sensors
- 2 Digital output to read the status

Other characteristics

- Output value in voltage or current, to be configured via software.
- Card configuration is made via software, through on-board USB
- Defined parameters can also be set via the Profibus interface.

3 - FUNCTIONAL SPECIFICATIONS

3.1 - Power supply

This card is designed for 24 to 30 VDC (typical 24 V) of a power supply. This power supply must correspond to the actual EMC standards. All inductivities at the same power supply (relays, valves) must be provided with an over voltage protection (varistors, freewheeling diodes).

It is recommended to use a regulated power supply (linear or switching mode) for the card supply and for the sensors.

3.2 - Electrical protections

All inputs and outputs are protected with suppressor diodes and RC-filters against transient overshoots.

3.3 - Digital Input

The card accepts digital input. The digital input must have a voltage from 12 to 24 V; Low level: <2V, high level >10V. Input resistance 25 kohm. See the block diagram at paragraph 4 for the electric connections.

3.4 - Reference signals

The reference signals run via Profibus, ID number 1810h.

3.5 - Position feedback values

The card accepts a digital feedback input from a sensor with any SSI interface with RS422 specifications. Bit, code and resolution are settable via software.

The max sensor resolution is 0,001 mm.

Eventually an analog input could be used as feedback. The card accepts a 0 ÷ 10 V (Ri 25 kOhm) or 4 ÷ 20 mA (Ri = 240 Ohm).

The analogue resolution is of 0,003 incl. oversampling for a max res. of 1 µm.



Using analog sensors, the SSI parameters in the software assume default preset values that the user must not change.

3.6 - Pressure feedback values

Pressure feedback can be analogue only, 0 ÷ 10 V (Ri 25 kOhm) or 4 ÷ 20 mA (Ri = 240 Ohm).

3.7 - Analog output values

Output values can be in voltage or current, to be configured via software (parameter SIGNAL:U). The same parameter defines the polarity also.

Voltage: ± 10 V Differential output PIN 15 and 16

Current: 4 ÷ 20 mA (PIN 15 to PIN 12).

3.8 - Digital Output

Two digital output are available, STATUS and READY, that are displayed by LED on the front panel.

Low level < 2 V High Level > max U_b (max 50 mA).

4 - WIRING DIAGRAM

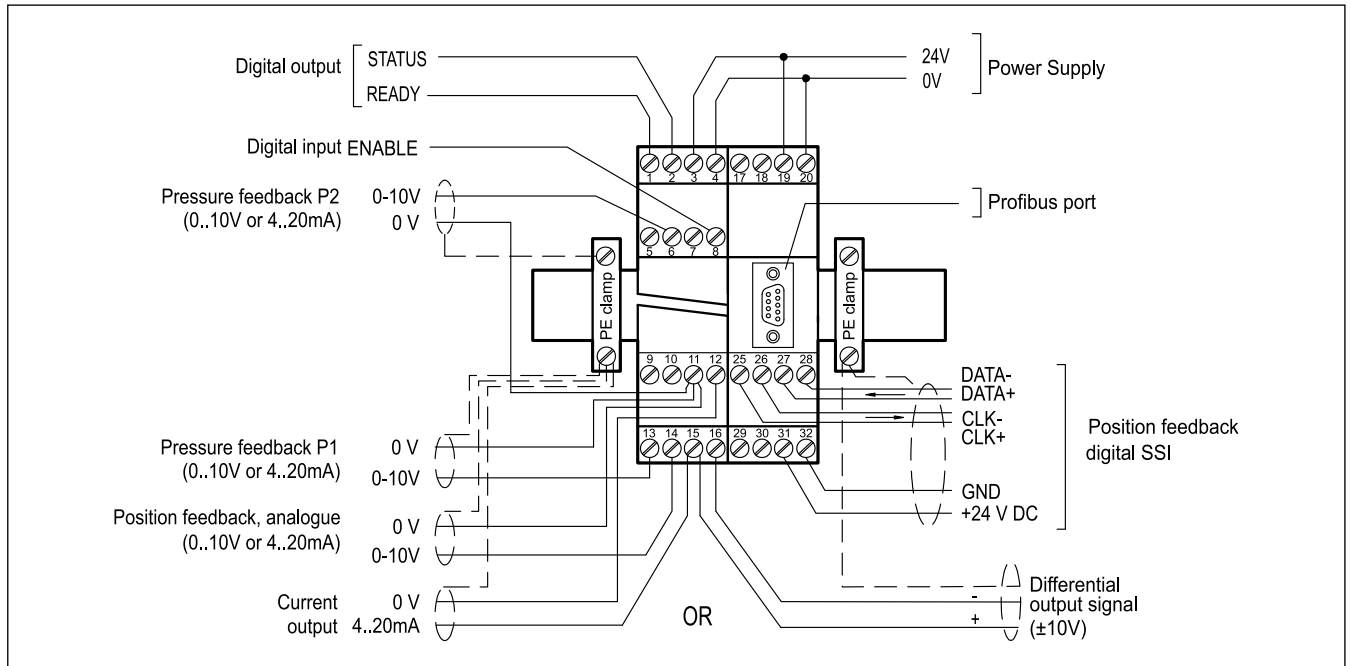

DIGITAL INPUT AND OUTPUT

- PIN 1** READY output.
General operability, ENABLE (PIN 8 and profibus bit) is active and there are no sensor errors. This output corresponds with the green led.
- PIN 2** STATUS output.
Monitoring of the control error (POSWIN). Depending on the POSWIN command, the status output will be deactivated, if the position difference is greater than the adjusted window. The output is only active if START bit (Profibus) = ON.
- PIN 8** ENABLE input:
This digital input signal initializes the application. The controller and the READY signal are activated. The output signal to the control element is enabled. Target position is set to actual position and the drive stays stationary, in closed loop. The Enable bit via profibus must be active, too.

ANALOGUE INPUT

- PIN 6** Analogue pressure feedback value (X2), range 0 ÷ 100% corresponds to 0 ÷ 10V or 4 ÷ 20 mA
- PIN 13** Analogue pressure feedback value (X1), range 0 ÷ 100% corresponds to 0 ÷ 10V or 4 ÷ 20 mA
- PIN 14** Analogue position feedback value, range 0 ÷ 100% corresponds to 0 ÷ 10V or 4 ÷ 20 mA

ANALOGUE OUTPUT voltage

- PIN 16/15** Differential output (U) ± 100% corresponds to ± 10V differential voltage

current

- PIN 12/15** ±100% corresponds to 4 ÷ 20 mA

SSI SENSOR INTERFACE

- PIN 25** CLK+ output
PIN 26 CLK- output
PIN 27 DATA+ input
PIN 28 DATA- input
PIN 31 24V Power supply of the SSI sensor
PIN 32 0V Power supply of the SSI sensor

5 - INSTALLATION

For power supply and solenoid connections are recommended cable sections of 0.75 mm² up to 20 m length, and of 1.00 mm² up to 40m length.

For other connections use cables with a shielded jacket, connected to GND only on the card side.

NOTE : To observe EMC requirements it is important that the control unit electrical connection is in strict compliance with the wiring diagram.

As a general rule, the valve and the electronic unit connection wires must be kept as far as possible from interference sources (e.g. power wires, electric motors, inverters and electrical switches).

Complete protection of the connection wires can be requested in environments with critical electromagnetic interferences.

5.1 Start-up

The module must be mounted and wired with attentions to EMC requirements. A star orientated ground connection should be used when other power consumers are sharing the same power supply. Following points have to be taken in account for wiring:

- Signal cable and power cable have to be wired separately.
- Analogue signal cables must be shielded.
- Other cables should be shielded in case of strong electrical disturbance (power relays, frequency controlled power driver) or at cable lengths > 3m.

With high frequency EMI inexpensive ferrite elements can be used.

Take in account a separation between the power part (and power cables) and signal part when arrange the areas inside the electrical cabinet. Experience shows us that the area next to the PLC (24 V area) is suitable.

Low impedance between PE "protected earth" and DIN-Rail should be used. Transient interference voltages at the terminals are discharged via DIN-Rail to the local PE. The screens have to be connected directly next to the module via PE terminals.

The power supply should be carried out voltage regulated (i. e. PWM controlled). The low impedance of controlled power supplies facilitates improved interference damping, therefore the signal resolution will be increased.

Switched inductance (relays and solenoids) operating from the same power supply has to be damped by surge protection elements directly by the inductance.

6 - DEVICE SETUP

Card set-up is possible via software only.

The system can be controlled in open loop, moving up and down the servo-cylinder with commands HAND:x, via Profibus only, to facilitate the adjustment of the card and its calibration. With these functions the setting-up and the adjustments become easy.

6.1 - Software EWMPC/20

The software EWMPC/20 can be easily downloaded from the Diplomatic MS website in the section SOFTWARE DOWNLOAD.

To connect the card to a PC or notebook is necessary a standard USB 2.0 cable A – B (standard USB printer cable).

Once connected, the software automatically recognises the card model and shows a table with all the available commands, their parameters, the default setting, the measuring unit and a brief explanation for correct set-up.

Some functions like baud rate setting, remote control mode, saving of process data for later evaluation are used to speed up the installation procedure.

The software is compliant with Microsoft OS Windows 7, 8. and 10.



WARNING! In cards from series 20 onwards, the default baud rate to select in the software has changed from 9600 baud to 57600 baud. This is adaptable in OPTION / SETTINGS / INTERFACE.

6.2 - Parameters table

The parameters table is available in English or German. The language is set in the parameters.

The parameter setting can be done at *standard* level, easier, or *expert*, where a greater number of parameters is displayed and can be customized.

For a complete list of the parameters and their settings please refer to the Technical Manual 89440-120 ETM.

7 - MAIN FEATURES

The EWM-SP-DAD is a card for positioning control loop (POS), that can operate also with a pressure limitation control (POS_PQ).

With only few parameters the controller can be optimized and the movement profile is preset via Profibus (position and velocity).

Here below an example of profile with a switch speed:

- the target position is command value 2 (P2) combined with velocity 2 (V2).
 - the switch over position is command value 1 (P1), combined with velocity 1 (V1).
- The switchpoint from high to low velocity is calculated depending on the speed V2 and the braking.

The switchpoint from low to high speed is made in the P1 position with the ramp acceleration, as shown below.

If the command position P2 is between the current position and the position value of P1, the positioning in P2 can only be driven with V1 velocity.

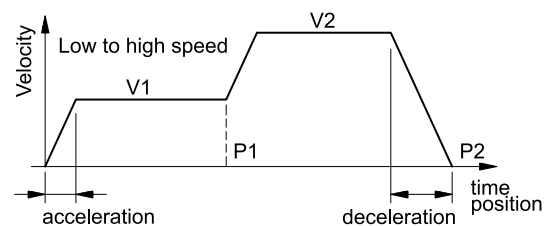
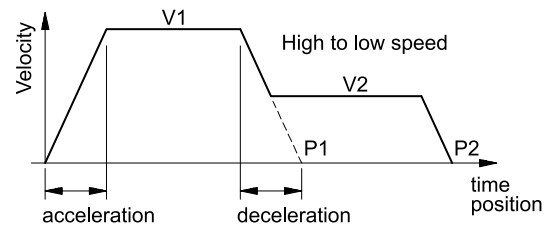

7.1 - Sequence of the positioning

You can switch from the positioning in closed loop to the manual movement in open loop and back via Profibus.

With READY active the system is ready. The open loop control is achieved by using the HAND bits and the speed parameter. When the bit HAND goes low the card assumes the current position as the request and the card is ready to work in closed loop.

With also START bit enabled, the command position parameter (profibus) become active and the new command position will be taken over as a new target.

The axis moves immediately to this new position and indicates on the Inpos Output when it reaches the position. This output is active as long as the axis is within the InPos window or the START bit is active.

Two methods for positioning are available:

SDD - stroke depending deceleration - means the control gain will be adjusted. This is a time-optimal positioning structure with very high stability.

NC mode - the position value is generated from the following error. The actuator position is measured by a transducer and compared with a specified target position. The target position and speed are set by Profibus.

The positioning accuracy will almost be limited by the resolution of the transducer, and by the right size of the hydraulic valve. Therefore, the correct valve selection is the most important point. Additionally, two clashing requirements (short positioning time and high accuracy) have to be considered in the system design.

7.2 - Pressure limitation control function:

The pressure limitation control requires a dynamic zero-overlapped control valve.

The pressure loop is managed according to the value of pressure measured just in one or in both the two chambers of the cylinder.

The control value for the pressure loop is set via profibus. If the pressure (or force) exceeds, the controller reduces the output signal to the valve (only in a negative scale) until it reaches the preset pressure value.

The switch from 'positioning mode' to 'pressure limitation' is handled automatically.

7.3 - Emergency Output (EOUT)

This function is able to set the output at a specific value when a failure occurs (e.g. sensor error or ENABLE disabled). It can be used to move the axis to one of the two end positions with a programmed velocity. The function can be deactivate.

7.4 - Adaptation of the braking characteristic to the valve type (CTRL).

The deceleration characteristic is set with this parameter. In case of positively overlapped proportional valves the SQRT function should be used. The non-linear flow function of these valves is linearized by the SQRT function.

In case of zero lapped valves (control valves and servo valves) the LIN or SQRT1 function should be used regardless of the application. The progressive characteristic of the SQRT1 function has better positioning accuracy but can also lead to longer positioning times in individual cases.

- LIN: Linear deceleration characteristic (gain is increased by a factor of 1).
- SQRT1: Root function for braking curve calculation. The gain is increased by a factor of 3 (in the target position). This is the default setting.
- SQRT2: Root function for braking curve calculation. The gain is increased by a factor of 5 (in the target position). This setting should only be used with a significantly progressive flow through the valve.

7.5 - Adaptation of the output signal to the valve characteristic (TRIGGER).

With TRIGGER command, the output signal is adapted to the valve characteristics.

The positioning controllers have a double-gain characteristic curve instead of a typical overlapped jump. The advantage is a better and more stable positioning behaviour. With this compensation, non-linear volume flow characteristic curves can be adjusted too.

If there exist also possibilities for adjustments at the valve or at the valve electronics, it has to be guaranteed, that the adjustment has to be carried out either at the power amplifier or at the positioning module.

If the deadband compensation value (MIN) is set too high, it influences the minimal velocity which cannot be adjusted any longer.

In extreme cases this causes to an oscillating around the closed loop controlled position.

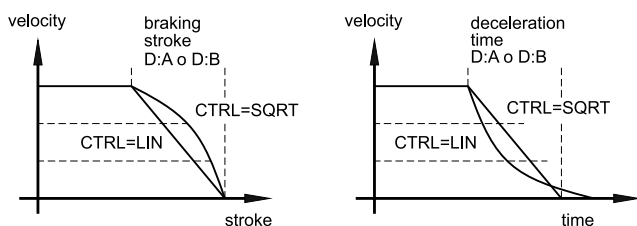
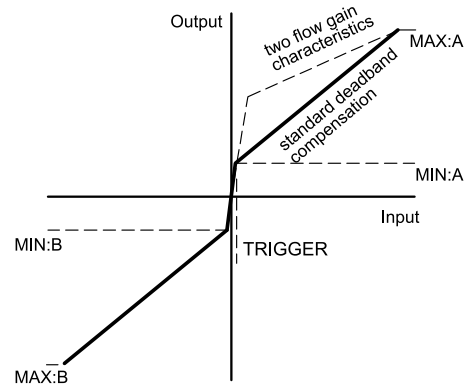



8 - CARD BLOCK DIAGRAM

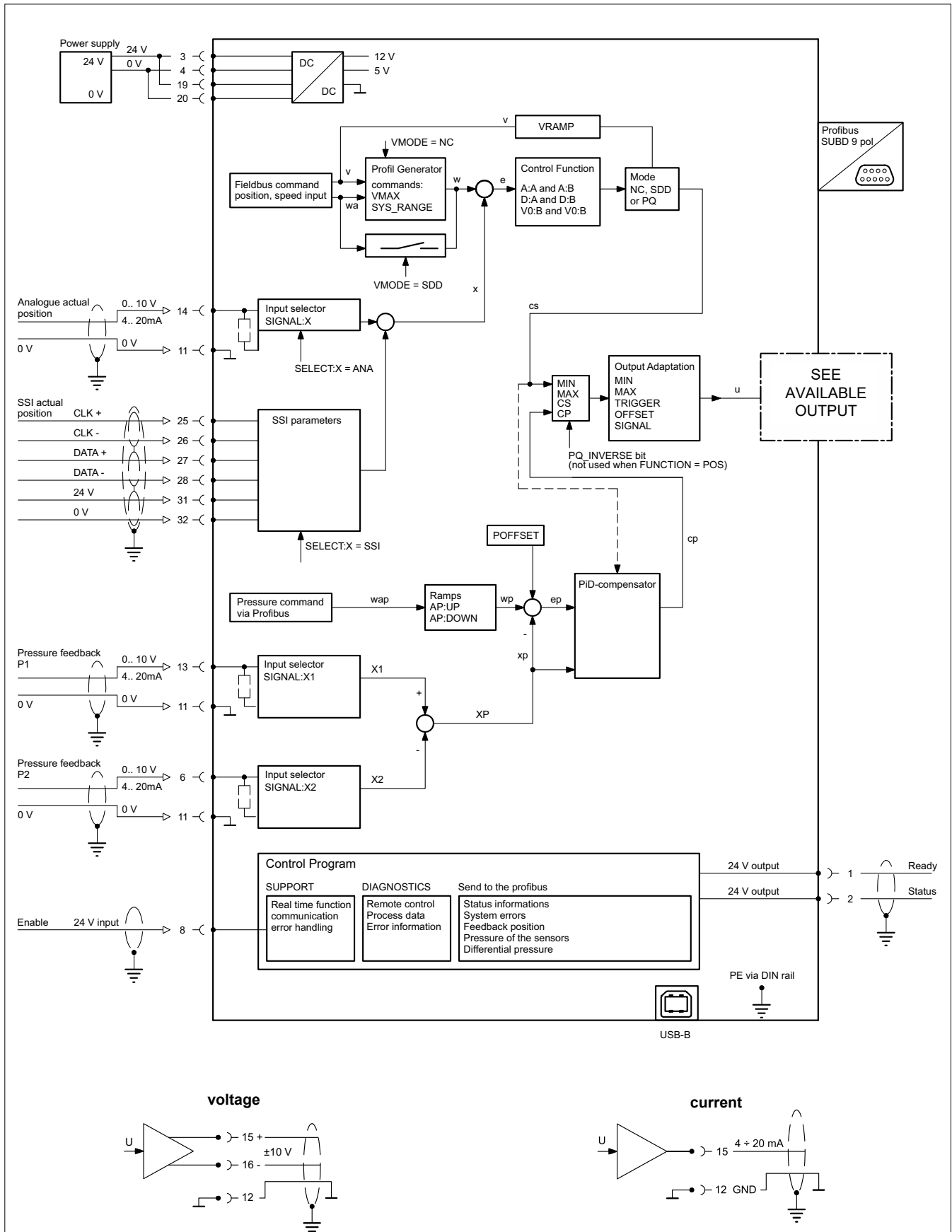

voltage

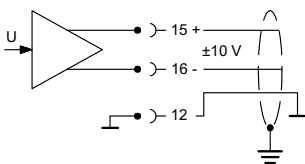

current

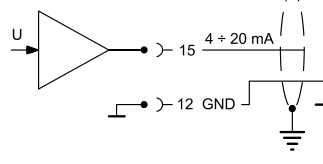

NOTE: If the card is configured as simple positioning control without pressure limitation then the output value is calculated just from the output of the position controller (CS) instead of apply MIN and MAX parameters. MIN/MAX are selected by the PQ_INVERSE bit (Profibus).

9 - OVERALL AND MOUNTING DIMENSIONS

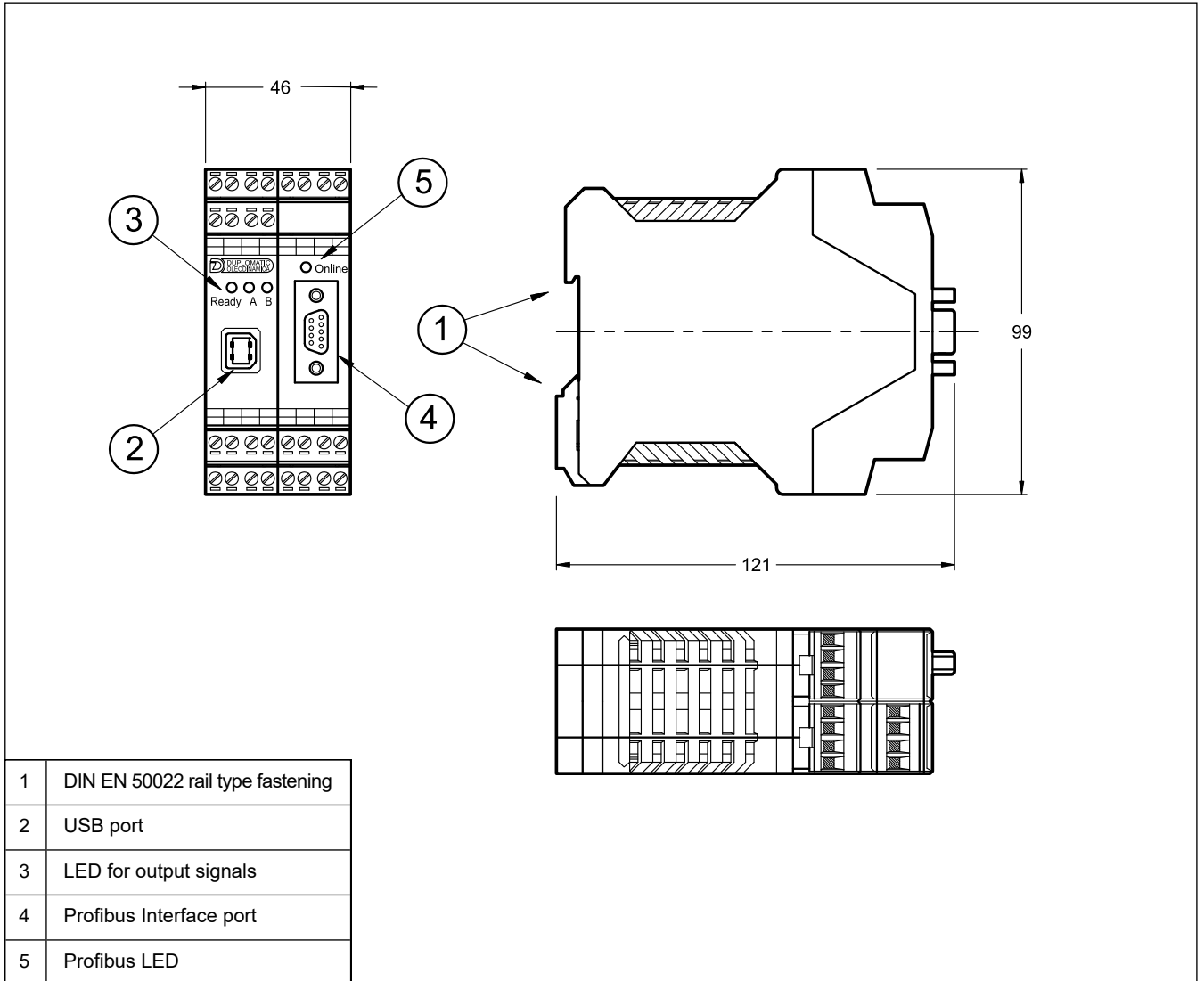



EWM-SP-DAD

SERIES 21

DUPLOMATIC
MOTION SOLUTIONS
*a member of **DAIKIN** group*

DUPLOMATIC MS Spa

via Mario Re Depaolini, 24 | 20015 Parabiago (MI) | Italy

T +39 0331 895111 | E vendite.ita@duplomatic.com | sales.exp@duplomatic.com
duplomaticmotionsolutions.com